

# BASO 1.5 / 2.5 / 4.0 T-BAR suspended

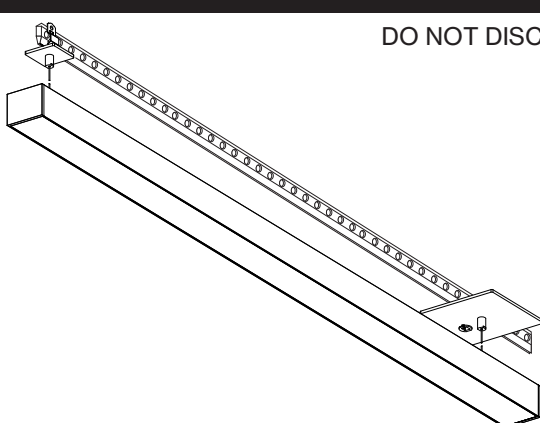



## MOUNTING INSTRUCTIONS

### SUSPENDED







**DO NOT DISCARD!**

#### SIGN LEGEND

-  POWER OFF
-  POWER ON
-  DON'T TOUCH THE LED
-  ATTENTION
-  USE ESD GLOVES

#### TOOLS REQUIRED (not included)

-  pencil
-  screwdriver
-  drill
-  ESD gloves
-  level

---

#### BASO 1.5

direct

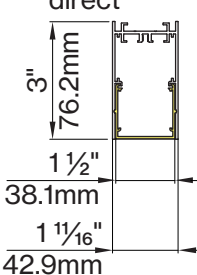

3"  
76.2mm

1 1/2"  
38.1mm

1 1/16"  
42.9mm

direct / indirect

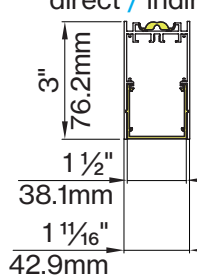

3"  
76.2mm

1 1/2"  
38.1mm

1 1/16"  
42.9mm

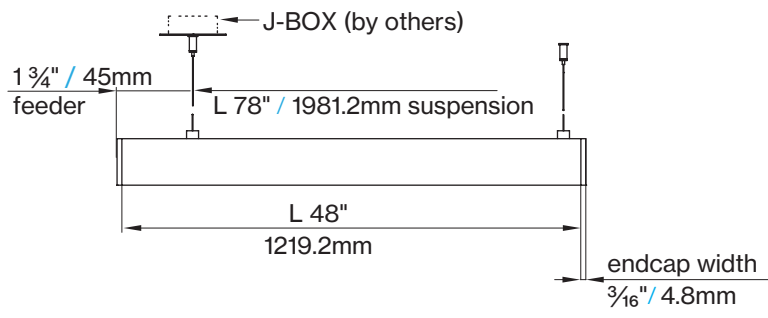

J-BOX (by others)

1 3/4" / 45mm feeder

L 78" / 1981.2mm suspension

L 48" / 1219.2mm

endcap width 3/16" / 4.8mm

---

#### BASO 2.5

direct

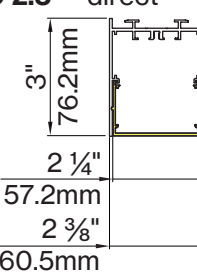

3"  
76.2mm

2 1/4"  
57.2mm

2 3/8"  
60.5mm

direct / indirect

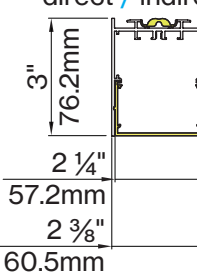

3"  
76.2mm

2 1/4"  
57.2mm

2 3/8"  
60.5mm

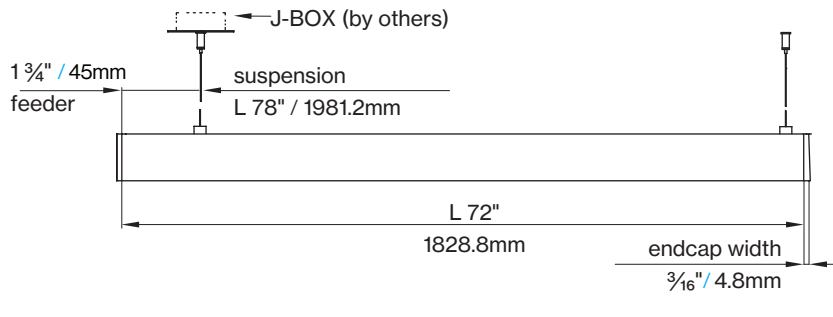

J-BOX (by others)

1 3/4" / 45mm feeder

suspension L 78" / 1981.2mm

L 72" / 1828.8mm

endcap width 3/16" / 4.8mm

---

#### BASO 4.0

direct

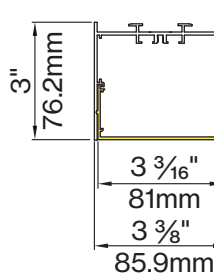

3"  
76.2mm

3 3/16"  
81mm

3 3/8"  
85.9mm

direct / indirect

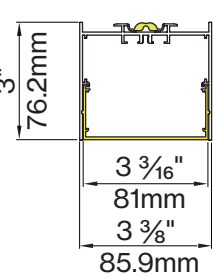

3"  
76.2mm

3 3/16"  
81mm

3 3/8"  
85.9mm

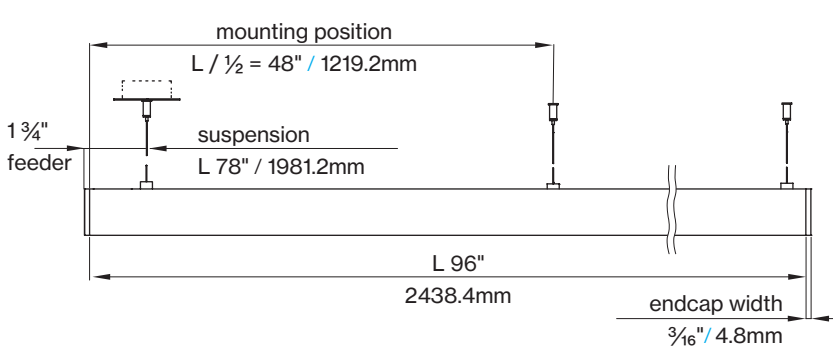

mounting position L 1/2 = 48" / 1219.2mm

1 3/4" feeder

suspension L 78" / 1981.2mm

L 96" / 2438.4mm

endcap width 3/16" / 4.8mm

# BASO 1.5 / 2.5 / 4.0 T-BAR suspended

## MOUNTING INSTRUCTIONS

Turn **OFF** power source before installation

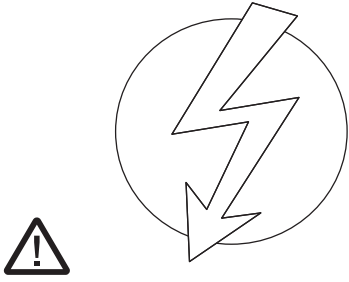

2. Remove surrounding ceiling tiles

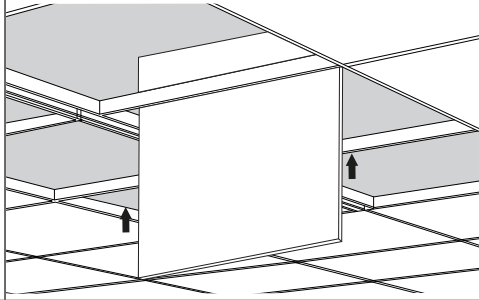

3. Mount T-BAR junction box onto T-BAR. (T-BAR junction box provided by others)

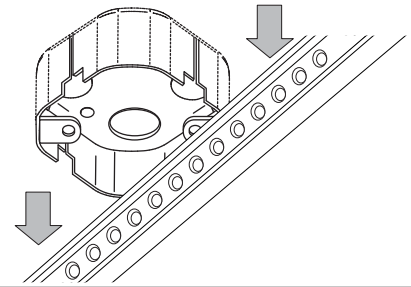

5. Thread aircraft cable through cover

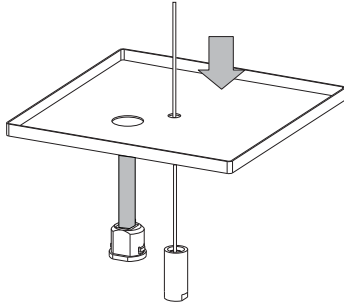

6. Thread power feed through cover plate

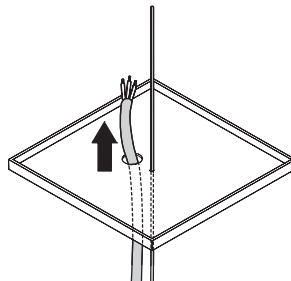

7. Thread power feed through the opening at the top of J-Box

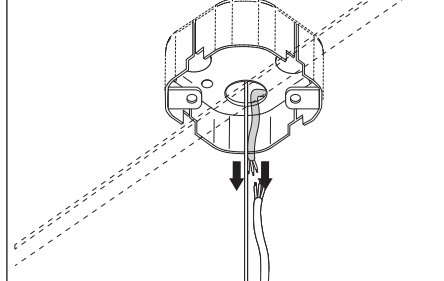

8. Connect wiring to power source

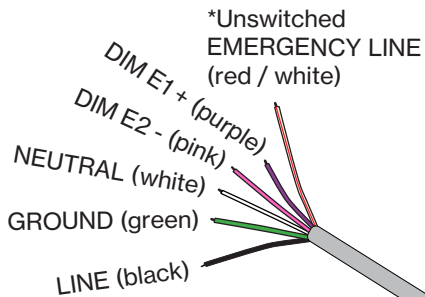

9. Align bracket to T-BAR junction box.

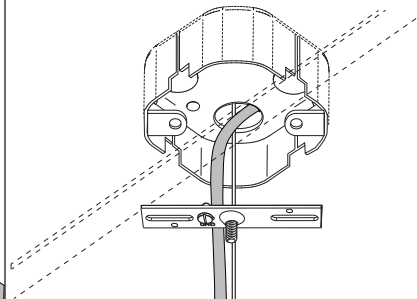

10. Screw bracket into junction box

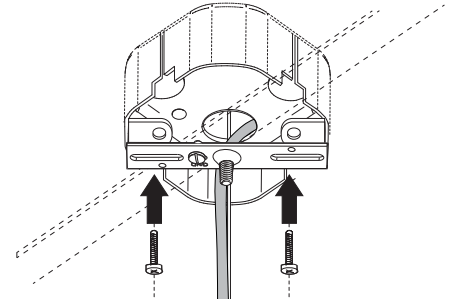

11. Screw cover plate into bracket through the barrel mount.

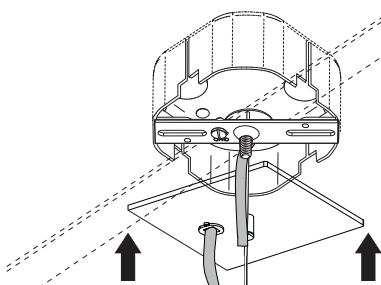

12. Attach the T-BAR clip to the T-BAR based on the mounting positions

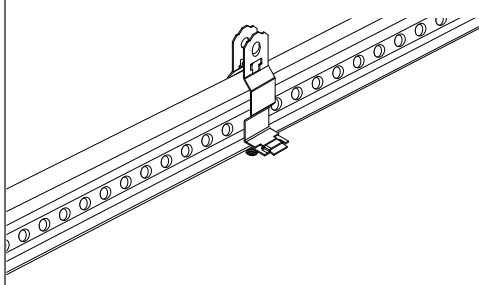

13. Secure the clip by clamping the octagonal opening to the T-BAR with pliers

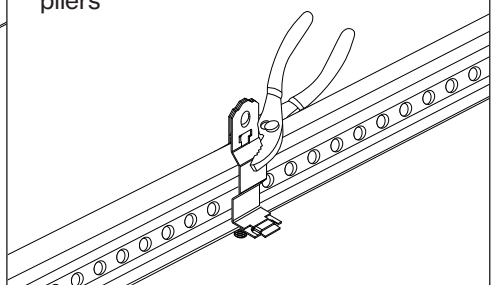

14. Secure T-BAR clips with suspension cables and attach to the structure above ceiling.

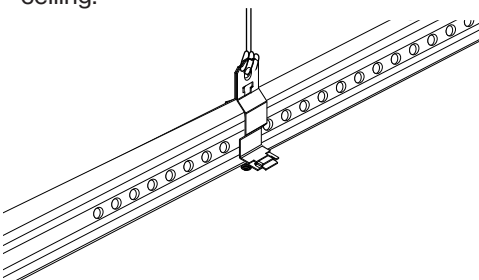

15. Screw in the cover underneath the T-BAR.

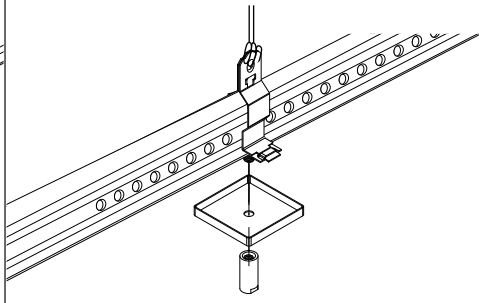

16. Remove inset / lens from channel

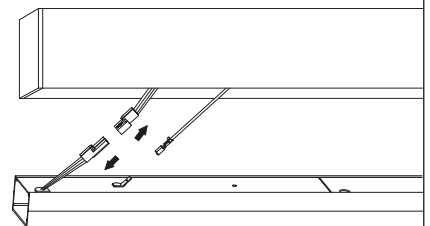

# BASO 1.5 / 2.5 / 4.0 T-BAR suspended

## MOUNTING INSTRUCTIONS

17. Attach the suspension clip to the channel. The clip snaps directly into the channel.

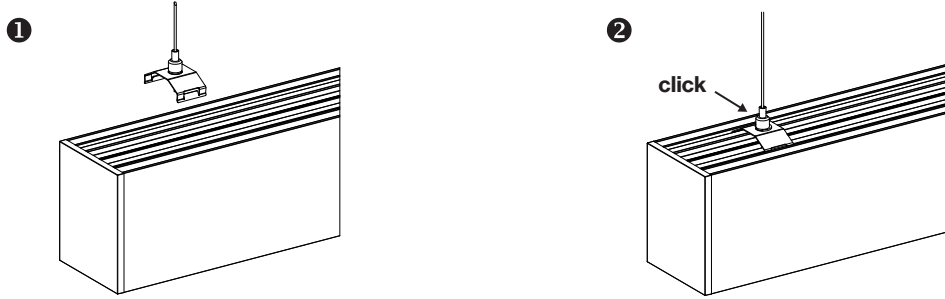

18. Adjust cables; once they are level, trim them



**Make sure fixture is level, before trimming cables!**

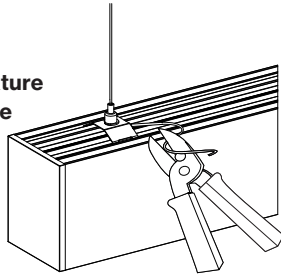

19. Secure power feed cable to suspension, cable every 3 inches using cable ties (cable ties provided by others)

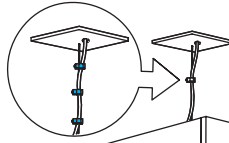

20. **SYSTEMS:** Slide connectors into channels

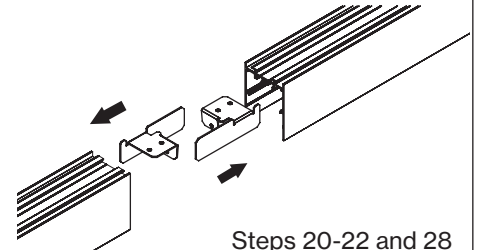

Steps 20-22 and 28 for continuous runs

21. **SYSTEMS:** Use screws to secure connectors to channels

tab should not be past end of the channel

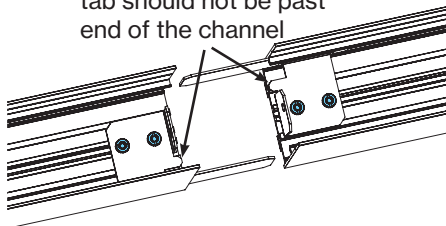

22. **SYSTEMS:** Slide channels together. Secure connectors with screw and nut.

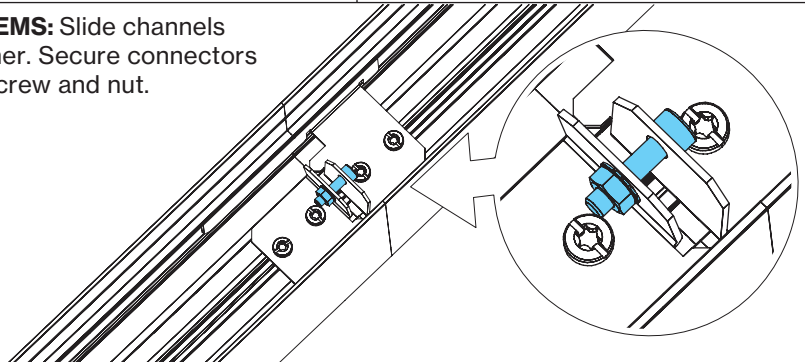

23. **SYSTEMS:** Apply black electrical tape to the interior of the channels (where channels meet)

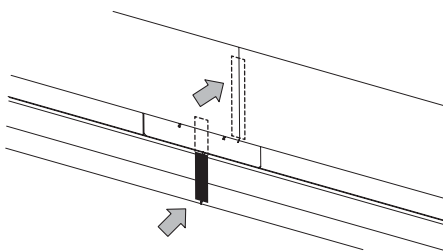

24. Establish primary connection to feeder

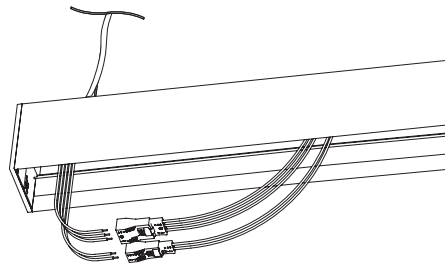

25. Establish connection between segments

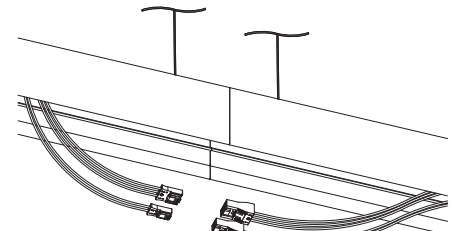

Repeat steps 16 - 21 for multiple channels

26. Test the channel grounding

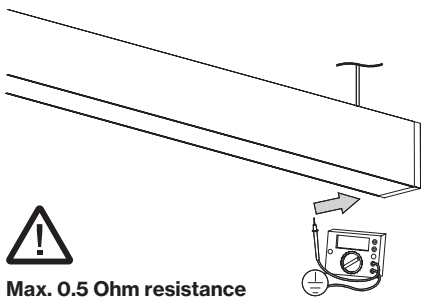

**Max. 0.5 Ohm resistance**

27. Connect inset(s) wiring, grounding clip and fall protection to channel(s)

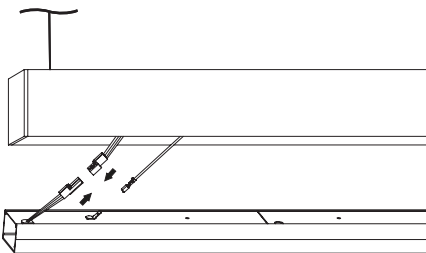

28. **SYSTEMS:** Make connection between segments

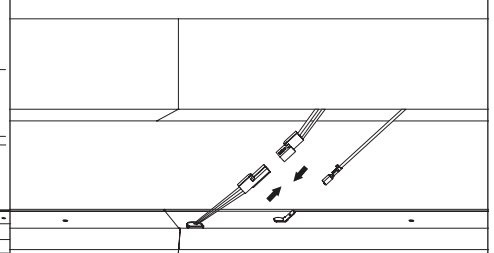

# BASO 1.5 / 2.5 / 4.0 T-BAR suspended

## MOUNTING INSTRUCTIONS

29. Insert inset/cover into channel.

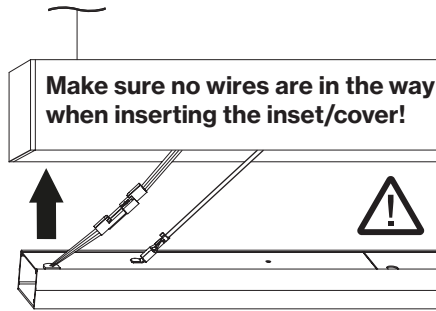

30. Installation complete

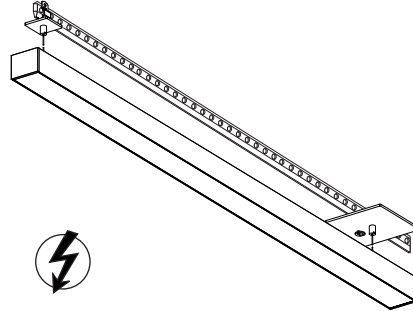

### IMPORTANT:

Cover must sit flush. If cover does not sit flush and is not fully engaged, it might fall. Due to changes in temperature, the acrylic can slightly shrink and expand. As long as they are installed correctly, the lighting fixtures are designed to accommodate those physical changes.

### WRONG

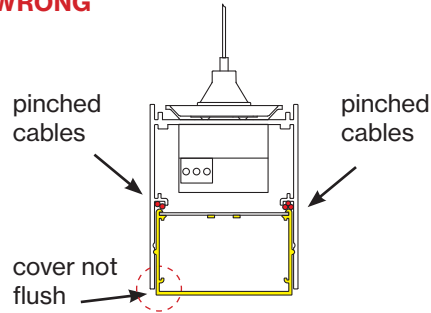

### IMPORTANT:

Quick connectors must be tucked in between drivers and open space in the fixture. Make sure quick connectors don't rest on the LED board.

### WRONG

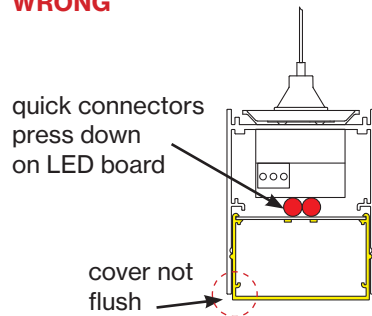

### RIGHT

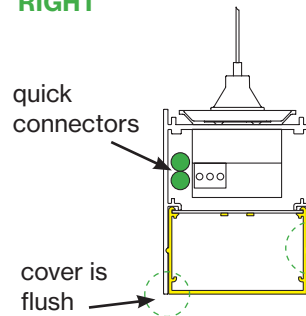

Cover must be fully engaged. You will feel a physical feedback and hear a "click" noise to confirm that the cover is engaged.

# BASO 1.5 / 2.5 / 4.0 suspended

## MOUNTING INSTRUCTIONS

### Technical Support Hotline

Call the Technical Support Hotline from  
Monday to Friday, 8 AM - 6 PM (EST)

Hotline:  
**+1 203 262 9990**

Or 24/7 via email:  
**support@basolighting.com**

**EN** Installation, commissioning and maintenance may only be performed by authorized and qualified personnel, taking into consideration these installation instructions and any standards and regulations applicable to the respective area of application. The electrical, mechanical and thermal suitability of the luminaire for the intended area of application must be ensured and the secure fastening of the luminaire after its installation must be controlled. Turn off supply voltage before replacing any lamps (if applicable) as well as before performing any other works on the luminaire (e.g. cleaning) and wait until luminaire and lamp have completely cooled off. Please refer to the installation notes of the lamp manufacturer when inserting, replacing and operating conventional lamps. Use a soft, damp cloth to clean the luminaire. To clean plastic components and reflectors, a standard pH neutral, alcohol-free, non-abrasive cleaning agent may also be used.

Keep these installation instructions in a safe place as reference for any future maintenance works.

1. The lamp is not suitable for outdoor use.
2. The lamp may only be used with a safety guard.
3. Damaged protection glasses and covers have to be replaced immediately.
4. Corrosive chemical products must not be used as this may have a detrimental effect on the luminaire.
5. No liability is accepted for any subsequent change of the luminaire.
6. LEDs are high-quality electronic components! Please avoid touching by hand the LED light emitting surface while assembling or replacing parts and during maintenance work.
7. To avoid damage of the profile, unevenness on the wall or ceiling must be leveled out before assembling the profiles. While assembling the profiles, make sure they do not deform in order to guarantee their proper function.
8. The light source contained in this luminaire shall only be replaced by the manufacturer or his service agent or a similar qualified person.
9. The LED circuit must always be closed, before the converter is connected to the main power. BASO does not assume any liability for damages resulting from nonobservance of this rule.
10. Luminous flux and connected electrical load are subject to an initial tolerance of up to +/-10%. Color temperature is subject to a tolerance of up to +/- 150 Kelvin from the nominal value.

**FR** Le montage et la maintenance peut être effectué par spécialistes respectant les normes y régles valides. Assurer l'aptitude thermique, mécanique et électrique pour l'emploi prévue et assurer la fixation de la luminaire. Éteindre la tension avant de changer les lampes (si applicable) ou avant de réaliser travaux (p.ex nettoyage) a la luminaire. Attendre jusqu'à ce que la luminaire et les lampes ont fraîchit complètement. Merci de bien vouloir vous référer aux notes d'installation du fabricant de la lampe lors de l'insertion, le remplacement et la mise en route, avec des lampes conventionnelles. Pour nettoyer la luminaire utiliser un drap humide et doux. Pour nettoyer les parties du plastique ou les réflecteurs on peut utiliser encore un produit de nettoyage sans alcool qui ne fraye pas le material. Garder cette notice de montage pour possibles travaux de maintenance.

1. La luminaire n' est pas apte pour l'utilizaje exterior.
2. Utilizer la luminaire seulement avec un dispositif de sécurité
3. Changer immédiatement des verres de sécurité defectes ou bien des écrans de protection.
4. Evitez tout contact de la lampe avec de produits chimiques corrosifs.
5. Nous déclinons toute responsabilité en cas de modifications ultérieures.
6. Des LEDs sont des composants électroniques de haute qualité! Eviter tout contact direct de la surface de sorti de lumière de la LED avec les mains lors du montage ou des les travaux de maintenance de la lampe.
7. Pour éviter 'endommagement du profil, il est nécessaire de compenser les irrégularités du mur ou du plafond avant le montage des profils. Pour garantir un fonctionnement irréprochable des profils, il ne faut pas déformer les profils lors du montage.
8. La source du luminaire peut être remplace uniquement par le fabricant ou un tiers habilité.
9. Il faut que le circuit de LED soit fermé avant de connecter le convertisseur. BASO ne assume pas la garantie si cette norme ne se respecte pas.
10. La puissance et le flux lumineux affichent d'origine une tolérance de +/-10 %. Tolérance de la couleur de température : +/- 150 Kelvin.

**ES** La instalación, la puesta en marcha y el mantenimiento sólo deben realizarse por personal especializado considerando esta guía de instalación y todas las normas y reglamentaciones vigentes. Asegurarse de la aptitud eléctrica, mecánica y térmica de la luminaria para la aplicación prevista y comprobar la fijación segura de la luminaria después de su instalación. Apagar siempre la corriente antes de cambiar la lampara (en caso justificado) o de realizar algún otro trabajo en esta (p.ej. Limpieza). Esperar hasta que se enfríen la luminaria y la lampara completamente. Tener en cuenta las instrucciones de montaje del fabricante al colocar, cambiar y utilizar lamparas convencionales. Para la limpieza de la luminaria utilizar un paño suave y húmedo. Para limpiar componentes de plástico y reflectores puede usar también un limpiador pH neutral y sin alcohol que no roce el material. Guardar esta guía de instalación para trabajos de mantenimiento.

1. La luminaria no es apta para utilizarla en el exterior.
2. La luminaria solo debe accionar con un dispositivo de seguridad.
3. Cambie de inmediato los vidrios y las tapas de protección dañados.
4. Químicos que tienen efectos corrosivos no deben influir en la luminaria.
5. Para modificaciones futuras en la luminaria no se asume ninguna responsabilidad.
6. Los LED son componentes electrónicos de alta calidad! Por favor durante el montaje o el mantenimiento evite el contacto directo con la superficie de emisión.
7. Para evitar danos en el perfil, los desniveles de las paredes y techos deben ser enrasados antes del montaje de los perfiles. Para garantizar su buen funcionamiento, los perfiles no deben sufrir deformaciones durante el montaje.
8. La fuente luminosa contenida en esta luminaria debe ser reemplazada únicamente por el fabricante o su agente de servicio o similar persona cualificada.
9. El circuito LED debe ser cerrado antes de conectar el convertidor. BASO no asume garantía si esta norma nose respete.
10. La potencia original y el flujo luminoso presentan una tolerancia de +/-10%. Tolerancia de temperatura de color: +/- 150 Kelvin.

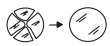

The lamp may only be operated with its full protective cover!

L'apparechio necessita del relativo vetro di protezione!

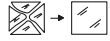

Sólo usar la luminaria con su cobertura de seguridad completa!



Recommended room temperature: 77 °F.

Temperatura ambiente recomendada: 77 °F.

Température ambiante recommandée: 77 °F.



Don't touch the LED



Use gloves.

Use guantes.

Utiliser des gants.